

Pallet Racking

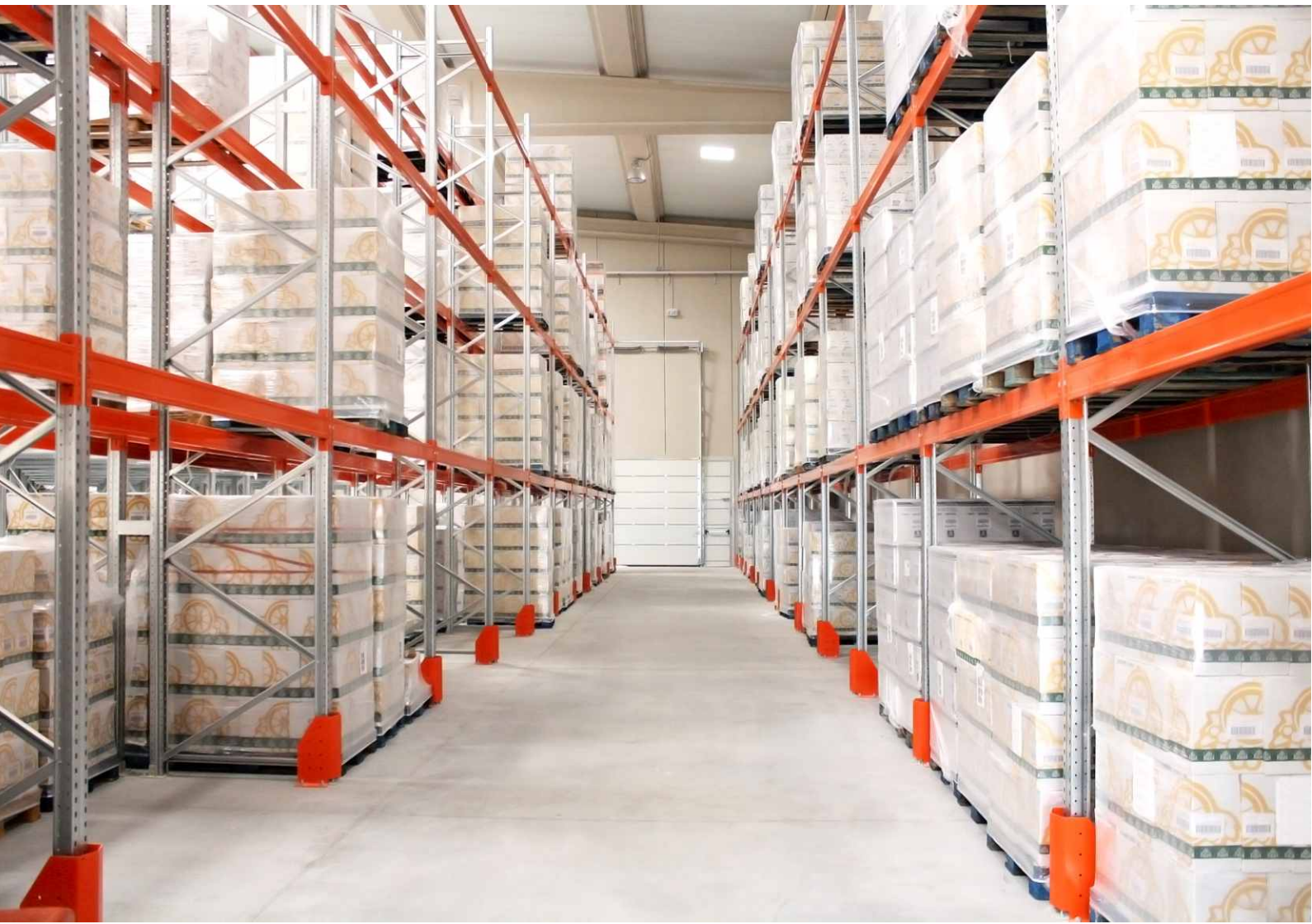



INNOVATION

One of the pillars that supports Esnova identifying values is the constant innovation. Innovating in order to improve is one of our targets, whether in new products or optimizing the current ones.

TECHNOLOGY

Esnova has invested in the most flexible and advanced production systems providing itself with necessary capacities for designing and manufacturing competitive metallic items, components and products in order to fulfill customers expectations.



Robotic Welding

FLEXIBILITY

Due to its technological potential, Esnova provides its production processes with a huge flexibility, making possible the new paradigm of Agile Manufacturing.

Quality

Quality as a priority standard is established in each and every process Esnova develops. The group invests in quality and safety and also promotes environmental respect. Certifications it holds are a sample of this:

- Quality Management System Certificate (ISO 9001).
- Environmental Management System (ISO 14001).
- Occupational Health and Safety Management (OHSAS 18001).
- Norm UNE EN 1090 CE-Marking.



Our high quality surface treatments guarantee a better product preservation.

Product finishings:

- ▶Epoxy polyester paint.
- ▶Galvanized.
- ▶Hot deep galvanized (HDG).

Epoxy-polyester Painting Line



We take care of our products packaging protecting them from possible friction and impact both in transport as well as in handling.

Pallet Racking System

Components

FOLDED BASE PLATE



Standard finishing

Pregalvanized

BASE PLATE

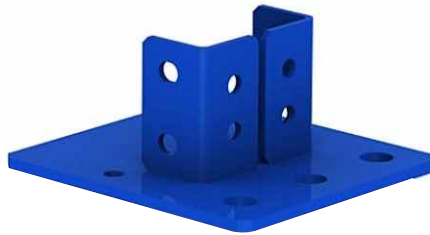

Standard finishing

Blue 5019

UPRIGHT ER

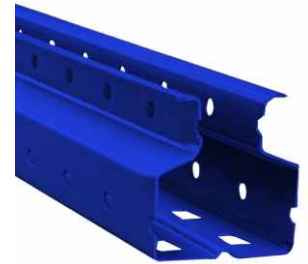

Standard finishing

Pregalvanized

Blue 5019

HORIZONTAL - DIAGONAL CZ

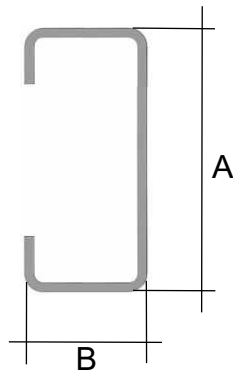

Description	Dimensions* (A x B)
CZ 36	36 x 13,6
CZ 42	42 x 25
CZ 50	50 x 32

*Dimensions in mm.

Standard finishing

Pregalvanized



Depth Frames (mm.) 800*-900-1000-1100*

*Standard Depth.

DUO CONNECTOR

For EGN beams



Standard finishing

Orange 2004

SAFETY CLIP



Standard finishing

Pregalvanized

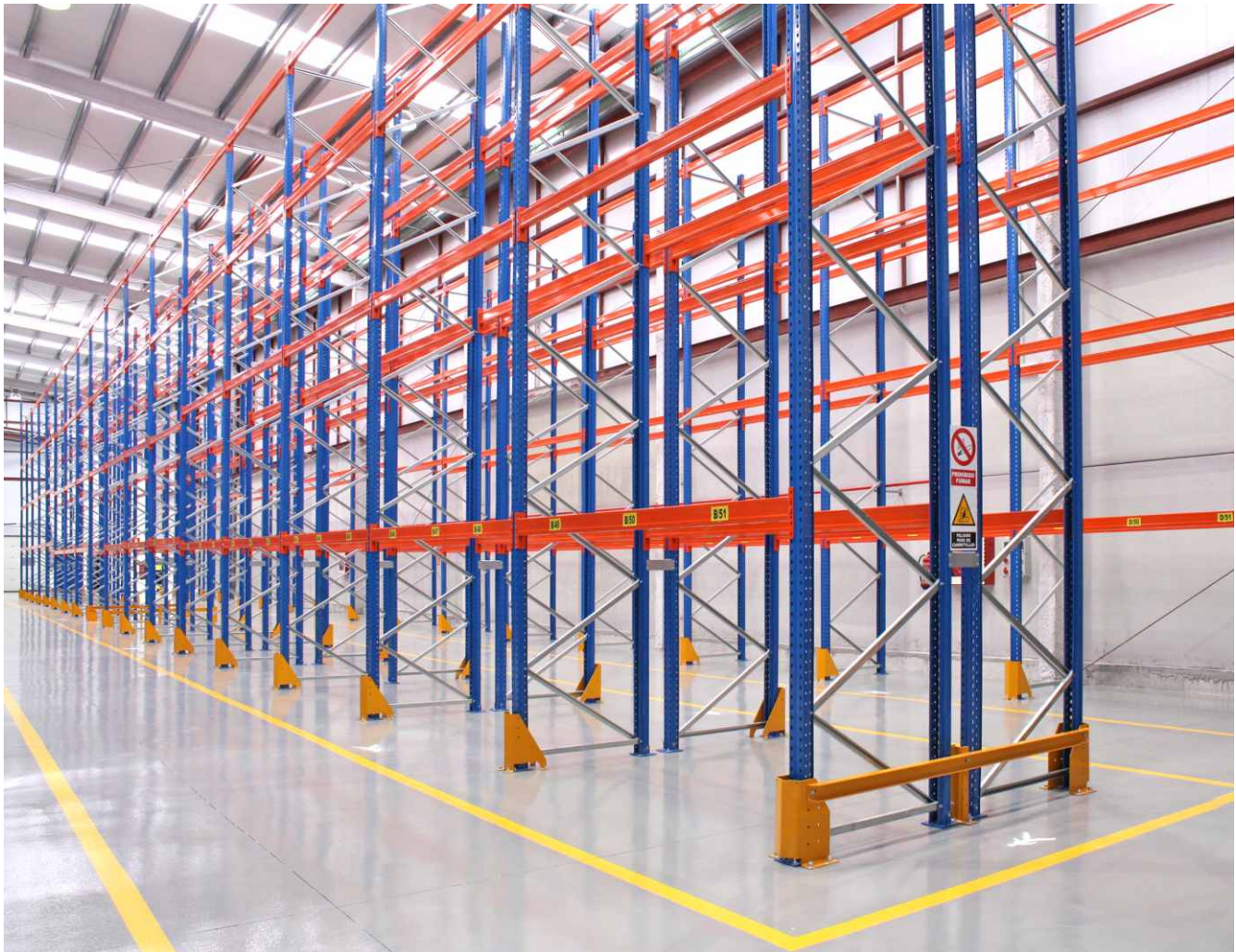

BEAM EGN



Dimensions* (A x B x e)	Connector
EGN 75x40x1,5	DUO
EGN 80x40x1,5	DUO
EGN 85x40x1,5	DUO
EGN 100x40x1,5	DUO
EGN 100x50x1,5	DUO
EGN 116x40x1,5	DUO
EGN 120x40x1,5	DUO
EGN 120x50x1,5	DUO
EGN 135x40x1,5	DUO
EGN 135x50x1,5	DUO
EGN 140x50x1,5	DUO
EGN 140x50x2	DUO
EGN 145x50x1,8	DUO
EGN 150x50x1,5	DUO
EGN 150x50x2	DUO
EGN 155x50x1,5	DUO
EGN 160x50x1,5	DUO
EGN 160x50x1,8	DUO
EGN 165x50x1,8	DUO

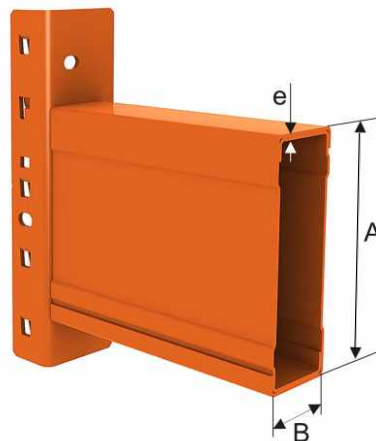

*Dimensions in mm.

*Dimensions in mm.

Uprights 76M & 76A

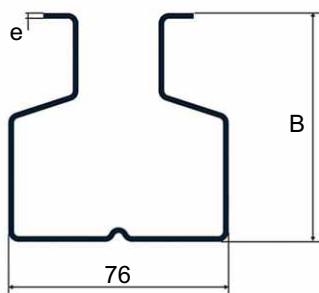

Description	Dimensions* (76 x B x e)	Frame profile	Base
ER76M15	76 x 63 x 1,5	CZ 36	RK6/76/A
ER76M18	76 x 63 x 1,8		
ER76M23	76 x 63 x 2,3		
ER76A15	76 x 79 x 1,5		
ER76A18	76 x 79 x 1,8		PLK5
ER76A20	76 x 79 x 2,0		
ER76A23	76 x 79 x 2,3		
ER76A25	76 x 79 x 2,5		

Option in galvanized finishing

Uprights 100A & 100B

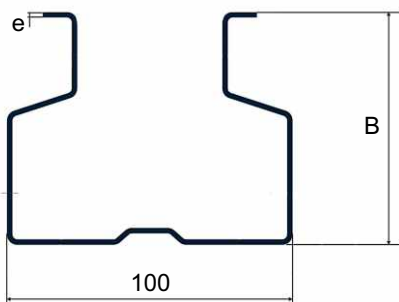

Description	Dimensions* (100 x B x e)	Frame profile	Base
ER100A18	100 x 81 x 1,8	CZ 42	RK6/100/A PLK5
ER100A20	100 x 81 x 2,0		
ER100A23	100 x 81 x 2,3		
ER100A25	100 x 81 x 2,5		
ER100B18	100 x 105 x 1,8		RK6/100/B RK8/100/C PLK5
ER100B20	100 x 105 x 2,0		
ER100B23	100 x 105 x 2,3		
ER100B25	100 x 105 x 2,5		
ER100B30	100 x 105 x 3,0		

Option in galvanized finishing

Uprights 115B & 115C

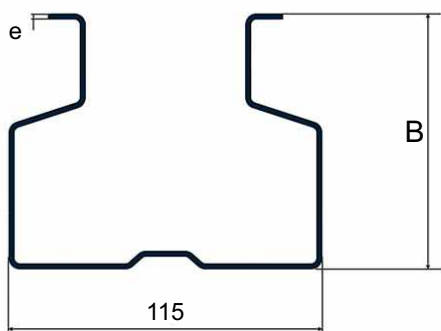

Description	Dimensions* (115 x B x e)	Frame profile	Base
ER115B18	115 x 98 x 1,8	CZ 50	RK8/115/A
ER115B20	115 x 98 x 2,0		
ER115B23	115 x 98 x 2,3		
ER115B25	115 x 98 x 2,5		
ER115C20	115 x 126 x 2,0		PLK5
ER115C25	115 x 126 x 2,5		
ER115C30	115 x 126 x 3,0		
ER115C35	115 x 126 x 3,5		

Option in galvanized finishing

Frame Depth (mm.) 800* - 900 - 1000 - 1100*

Standard Finishing Blue 5019

*Standard Depth.
Diagonals and horizontals finishing: Pregalvanized.

Galvanized finishing Thickness
1,5 - 2,0 - 2,5 - 3,0



Pallet racking adapted to store coils.



Accessories

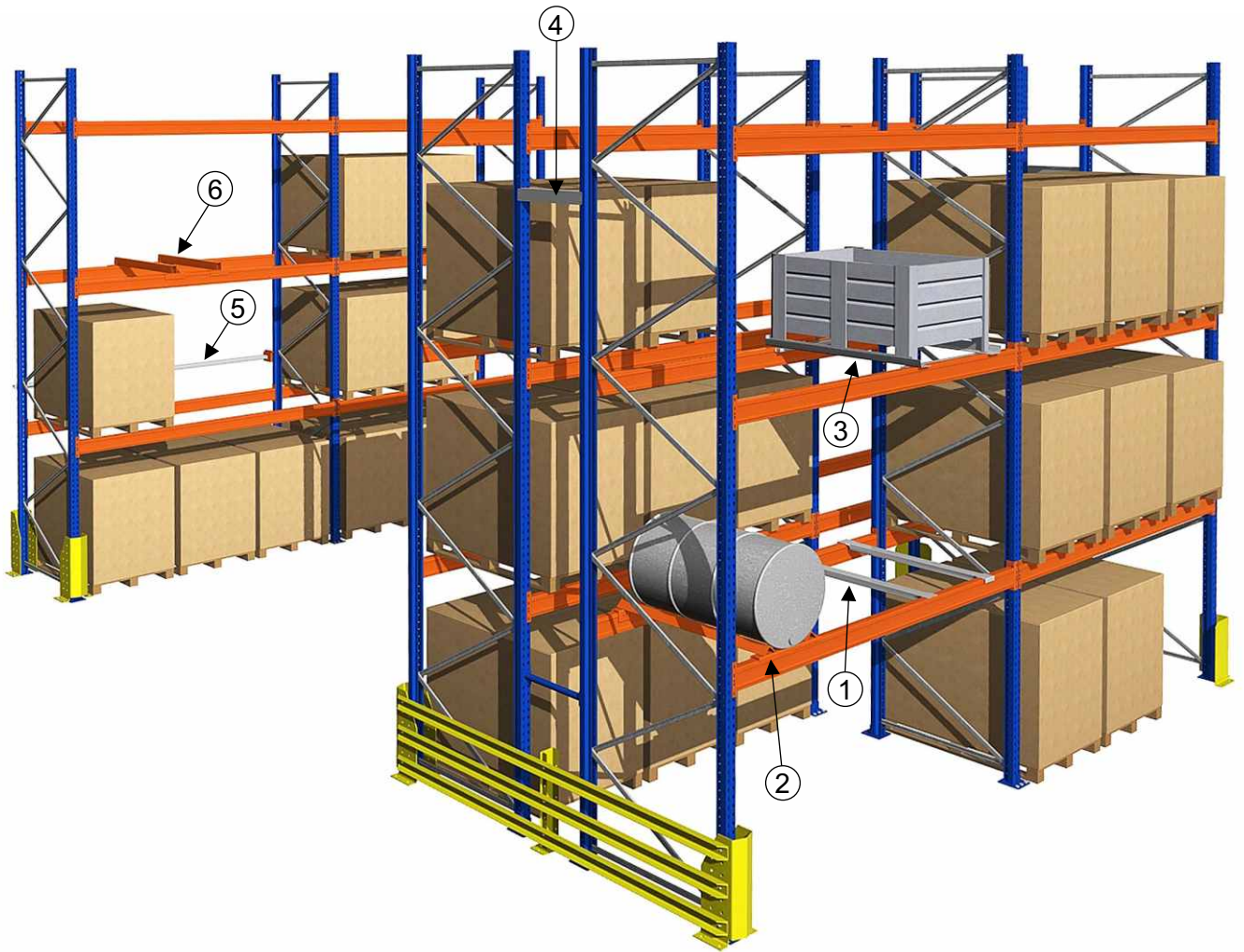

① **Cross Members**

Mod: TPCZF

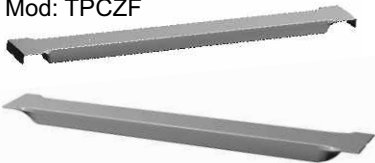

Mod: TPCZ

② **Drum Cradles SB**



③ **Container Support Sc1**



④ **Frame Spacers**

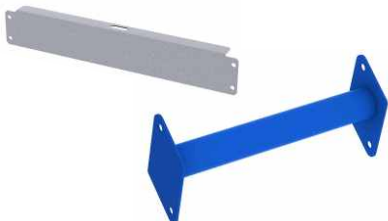

⑤ **Back Stop LTC**



⑥ **Elevated Tube Cross Member**



Aisle Spacer



Coil Bearing Rack Connector



Shim Plates

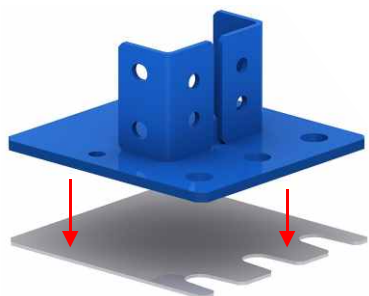

Z-Profile
To fix chipboards on beams.



Chipboards Stop
To be used with Crossmembers type TPCZF.

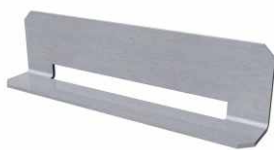

Shelf Grating (between supports)



Shelf Grating (over supports)



Steel Pannels (Pregalvanized)



Frame Splice



Vertical Bracings



Horizontal Bracings



Protections

Single Protection RK



Corner Protection DE



Full Frame Protection DIUD



Protection ECO



Full Frame Protection DIUS



Timber frame protector



Anti-Collapsing Mesh

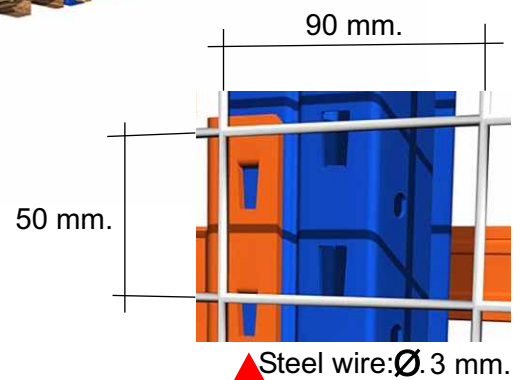
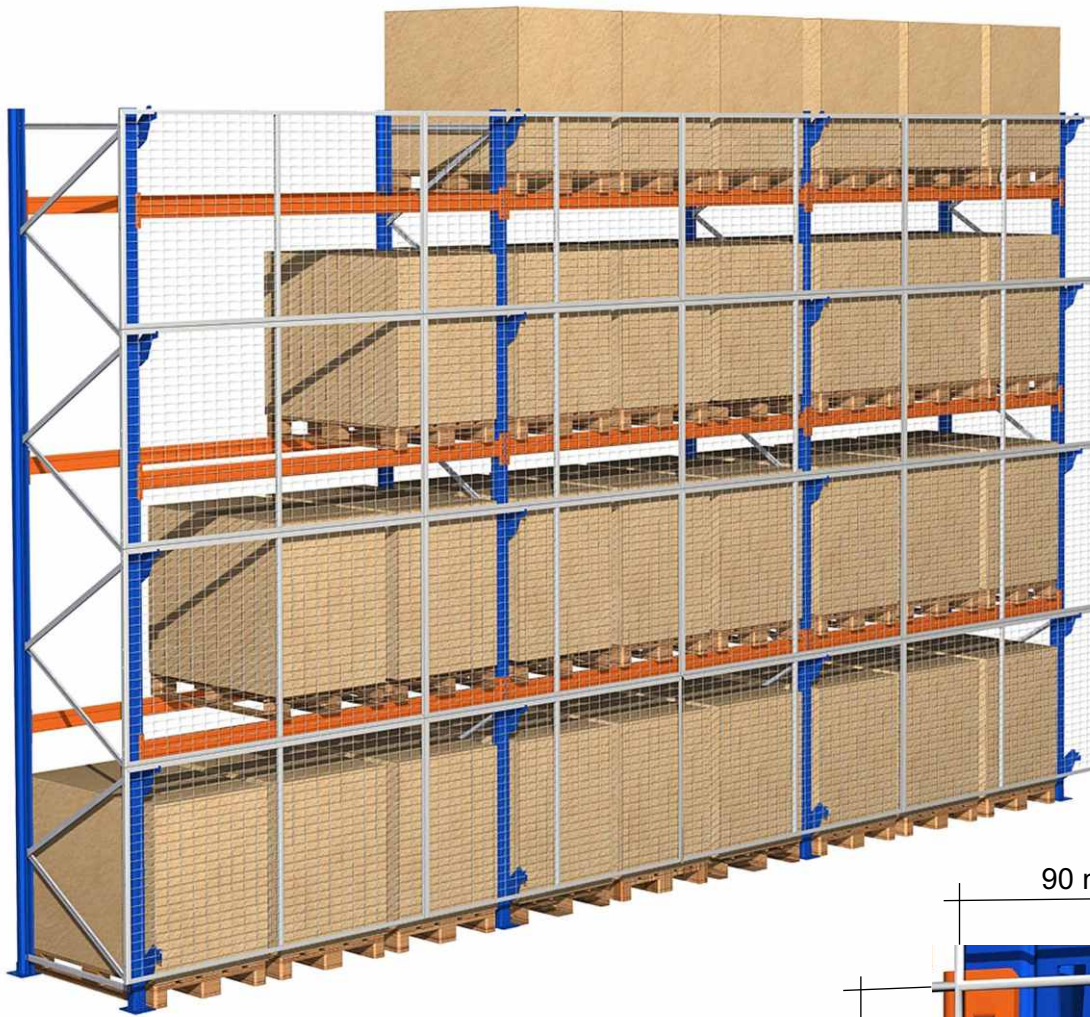

Electrowelded mesh panels are used as security closings in aisle or transit areas to avoid goods from falling.

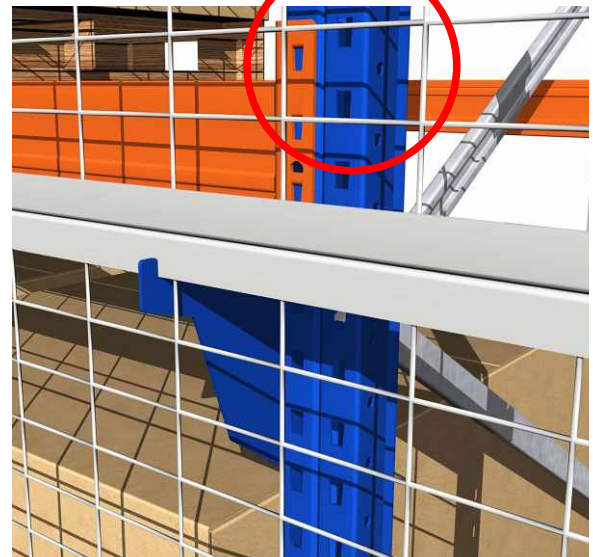
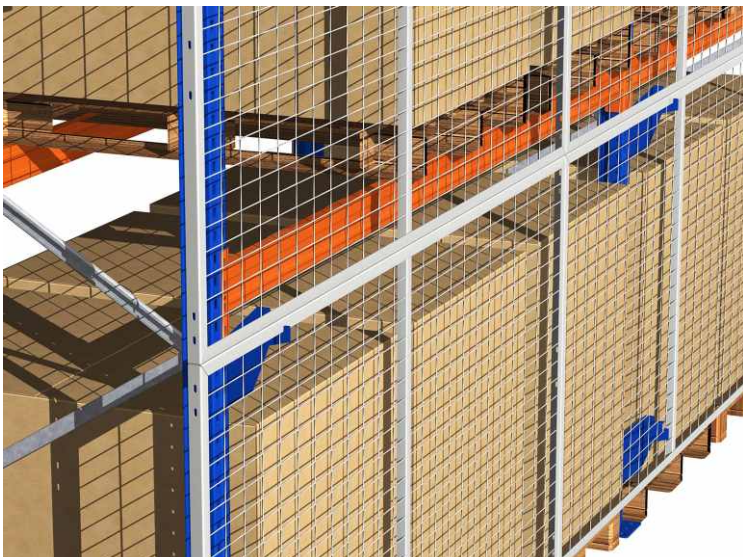

Home
 About Us
 Products
 Special Offers
 Contact

Click [HERE](#) to order our Products Catalogue NOW!!

New Age Services

New Age Services is an Irish owned Business established in 1971 by Managing Director Jack Phelan and are one of Irelands leading suppliers of storage systems, mezzanine floors and office furniture. We understand the need for well-designed, space-efficient workplaces. New Age Services major strength lies in the ability to provide a total service for our customers. From conception through to installation, we have the experience, capacity and commitment to find the answer to your storage or furniture requirement.

New Age Storage Systems Ltd., Unit 36, Rosemount Business Park, Ballycoolin Road, Dublin 11, Tel: 01 8128616, Fax: 01 8128620

www.newageservices.ie

**NEW AGE STORAGE SYSTEMS LTD.
 UNIT 36
 ROSEMOUNT BUSINESS PARK
 BALLYCOOLIN ROAD
 DUBLIN 11**

**TEL: (01) 812 8616
 FAX: (01) 812 8620
 Email: reception@newageservices.ie**



Esnova,
 Member of European
 Federation of Materials
 Handling (FEM).



- Esnova is certified on the norm UNE EN 1090 CE-Marking
- Esnova is certified for the Quality Management System (ISO 9001)
- Esnova is certified for the Environmental Management System (ISO 14001)
- Esnova is certified for the Occupational Health and Safety Management (OHSAS 18001)